

Standard Display

book

Year
2021

2021 Standard Display Book

Throughout our experience, we have found standard needs at the point of purchase, such as size, quick assembly and load structure.

The objective of this catalog is to offer display alternatives that are viable, creative and produced in record time.



Floorstand Interchangeable cover	Floorstand Quick Assembly	Floorstand Double - sided	Floorstand Metallic Reinforced	Floorstand Lego-like
Floorstand Reinforced	Sidekick	Small Sidekick	Long Sidekick	Endcap One-Piece PDQ Tray
Counter Display One-Piece PDQ Tray	Tiered Pallet Display	Double sided View	Pallet Display Dump Bin	Pallet Display
False Pallet	Maxi - Tray	Banner Display with base	Standee	



For a better interactive experience,
please download the app



Floorstand Interchangeable cover

SD_001

- Manufactured in corrugated cardboard
- Semi-automatic assembly
- Interchangeable cover to display different artworks reusing the same display frame
Ideal for multi-brand exhibitions and temporalities
- Unfold it to assemble and place cover on top

Assemble in

2
Minutes

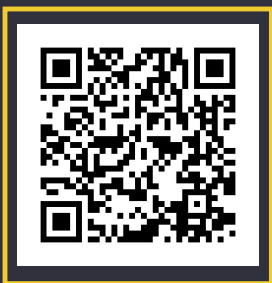

Video

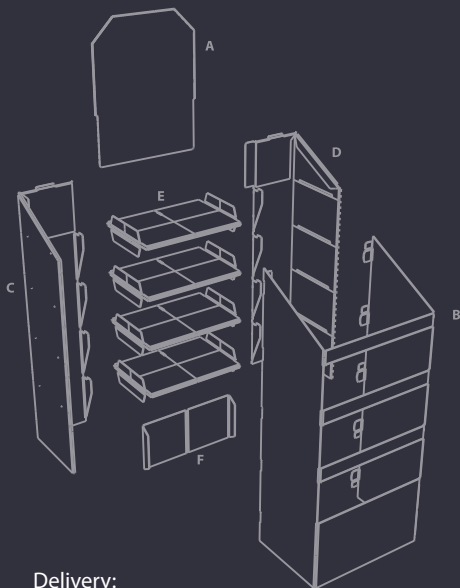

Delivery:
Folded in box;
on pallet

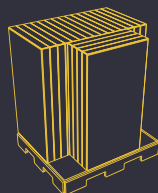

Perfect size to fit in a small car

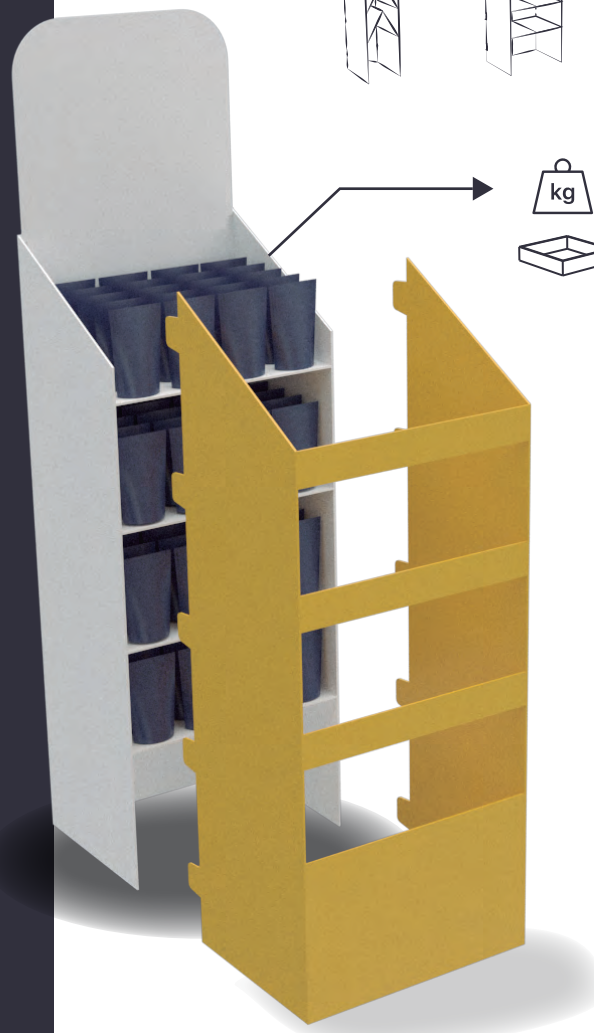
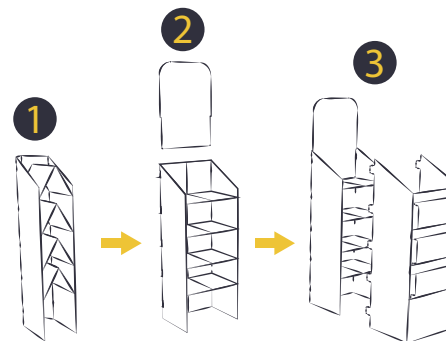

Load per level 4 kg

Space for product
34 cm x 43 cm



Augmented
Reality

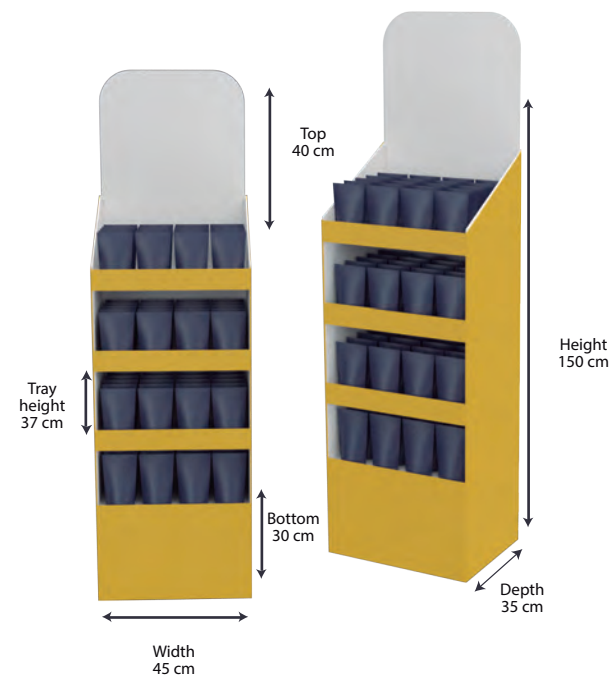

Floorstand Quick Assembly

SD_002

- Manufactured in corrugated cardboard
- Designed for extremely quick setup at retail
- Easy to transport
- Optimizes supply chain, eliminates hand assembly

- Unfold it to assemble, secure tray and place at retail.

Assemble in
1
Minute



Video

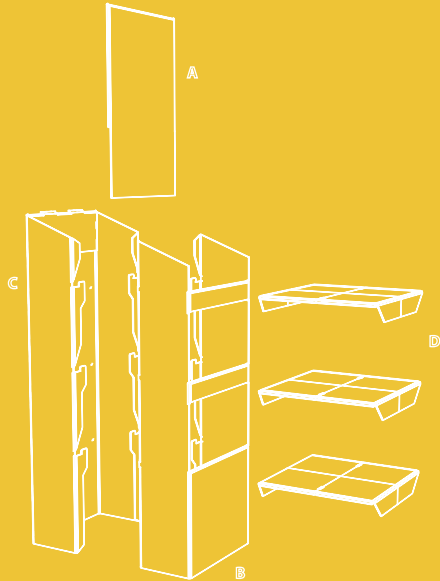

Delivery:
Folded in box;
on pallet

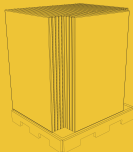

Perfect size to fit in a small car

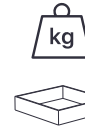
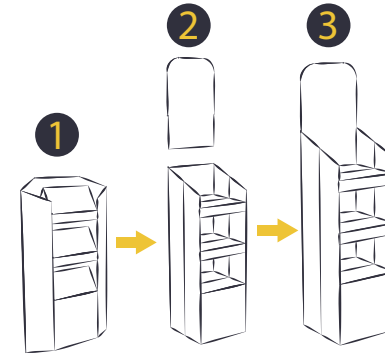
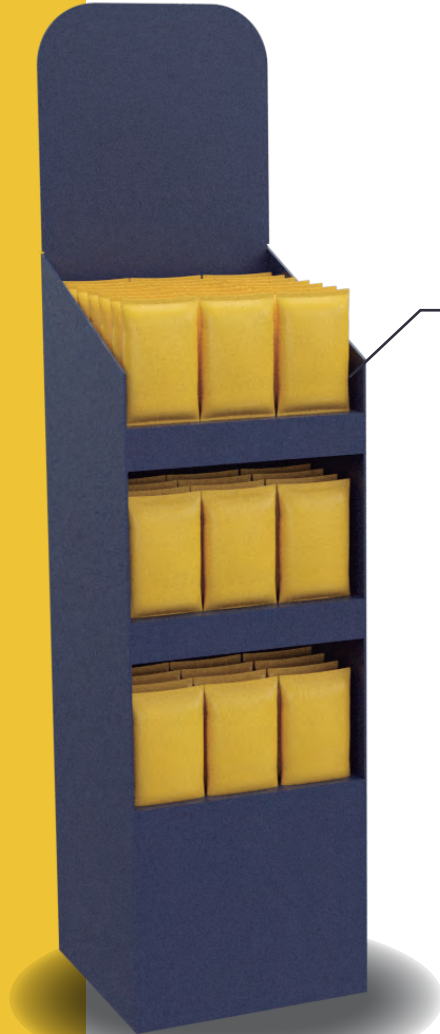

Load per level 6 Kg.

Space for product
39 x 37 cm

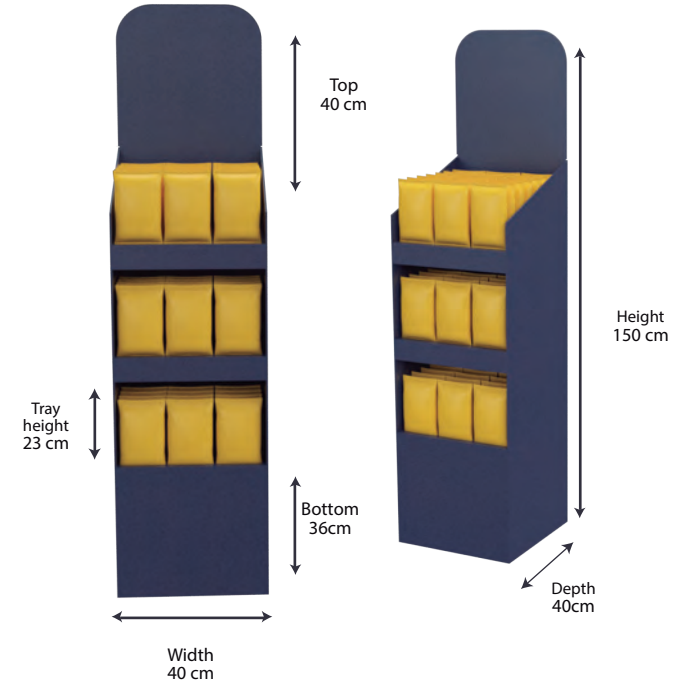

Augmented
Reality



Floorstand Double - sided

SD_003

- Manufactured in corrugated cardboard
- Pre-built trays
- Double-sided, more space for branding
- Easy to transport

- Unfold it to assemble, secure tray, top and place at retail.



Video

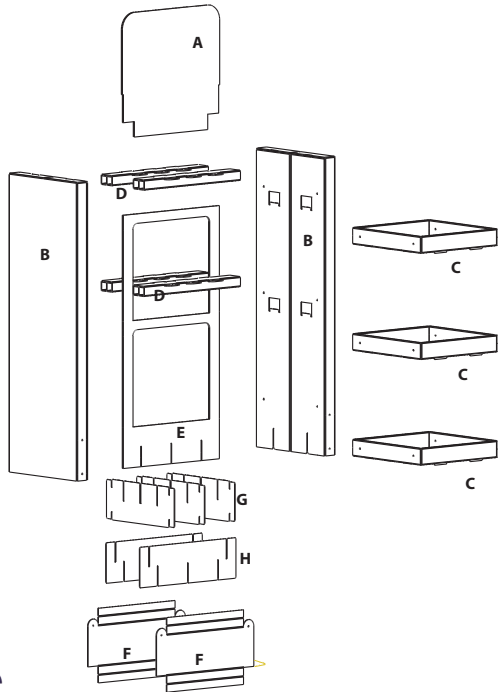

Perfect size to fit in a small car

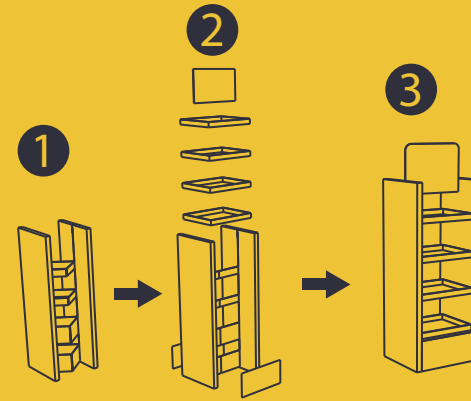

Load per level 6 Kg.



Space for product
39 x 37 cm



Augmented
Reality

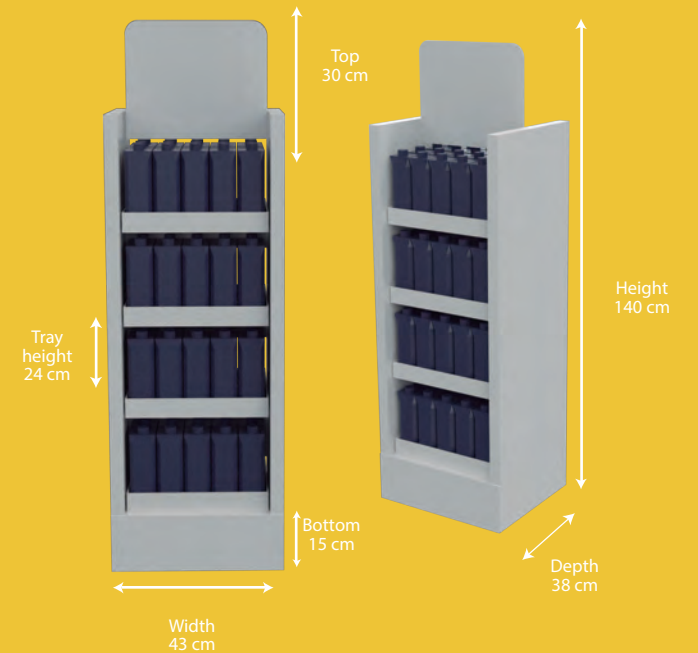

Floorstand Metallic Reinforced

SD_009

- Manufactured in corrugated cardboard
- Designed for quick setup at retail
- Metallic reinforced design to support heavier products
- Unfold it to assemble, place metal reinforcements and assemble trays to place at retail.

Assemble in
1
Minute



Video



Delivery:
Folded in box;
on pallet

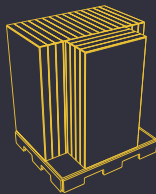

Perfect size to fit in a small car

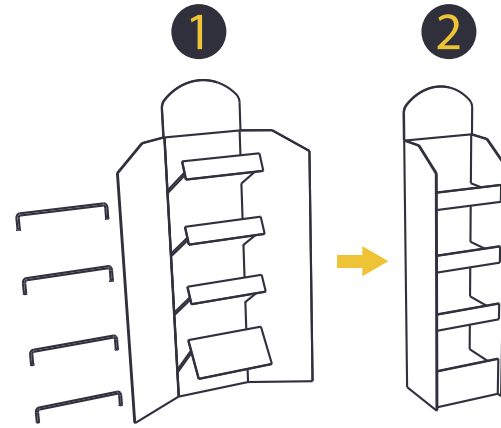
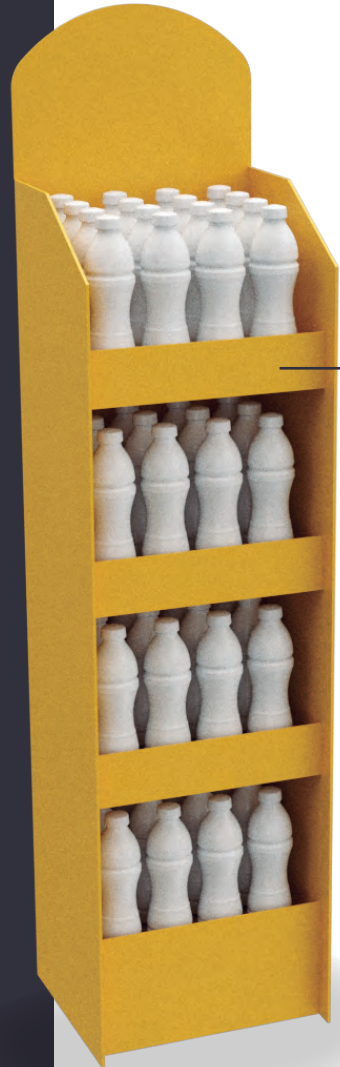

 Load per level 15 Kg.
 Space for product
34 x 27 cm

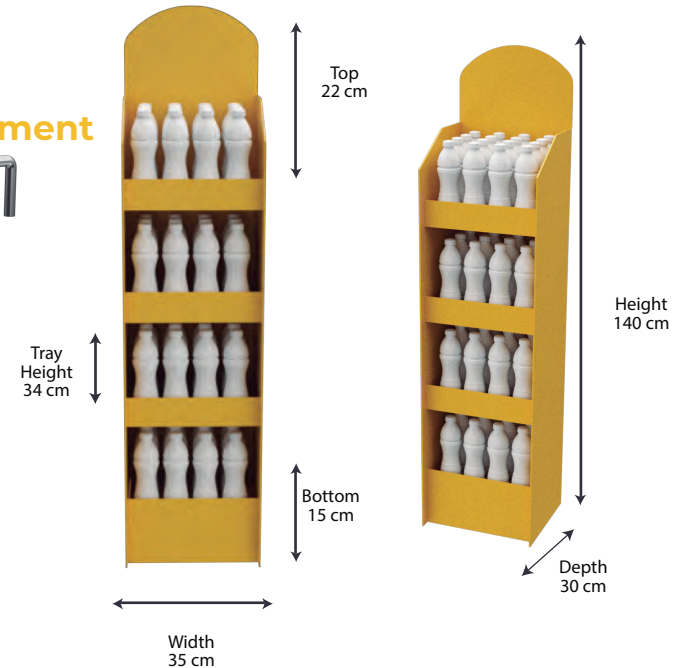

Augmented
Reality



Floorstand Lego-like

SD_005

- Manufactured in corrugated cardboard
- Semi-automatic assembly enable quick and easy setup at retail
- Modular stacking components
- Delivered in a cardboard briefcase

- Unfold it to assemble and stack components to place at retail.

Assemble in
2
Minutes

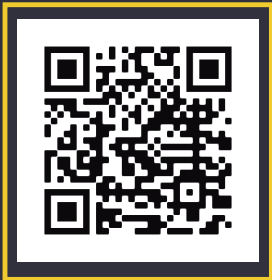

Video

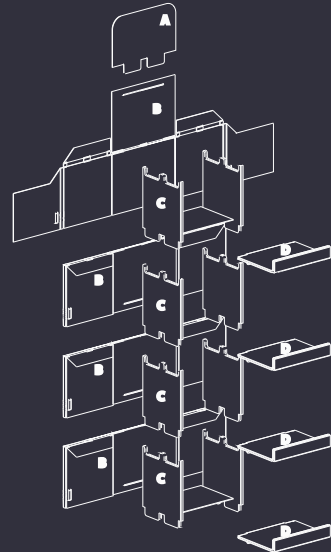

Delivery:
Folded in box;
on pallet



Perfect size to fit in a small car

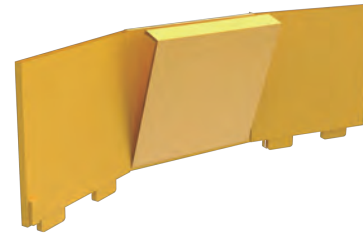

Augmented
Reality



Load per level 15 Kg.

Space for product
31 x 29 cm

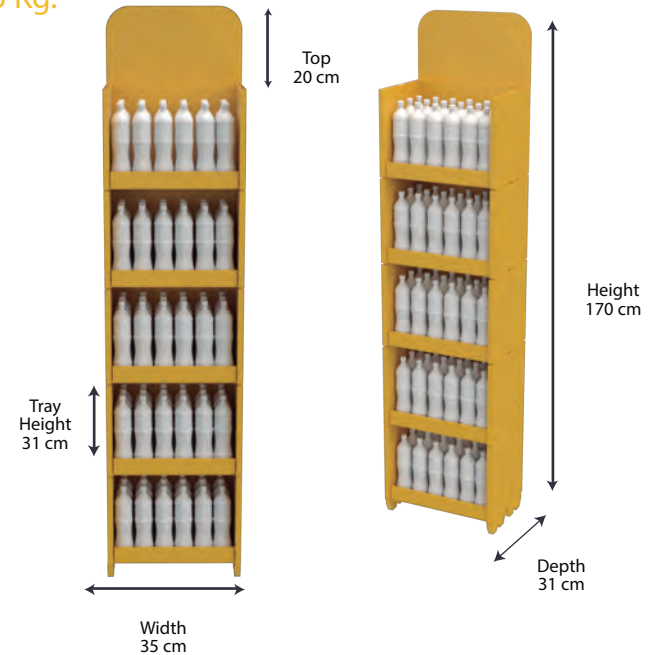

Floorstand Reinforced

SD_010

- Manufactured in corrugated cardboard
- Double sided, more space for branding
- Designed for quick setup at retail

- Unfold it to assemble, secure trays and place at retail.



Video

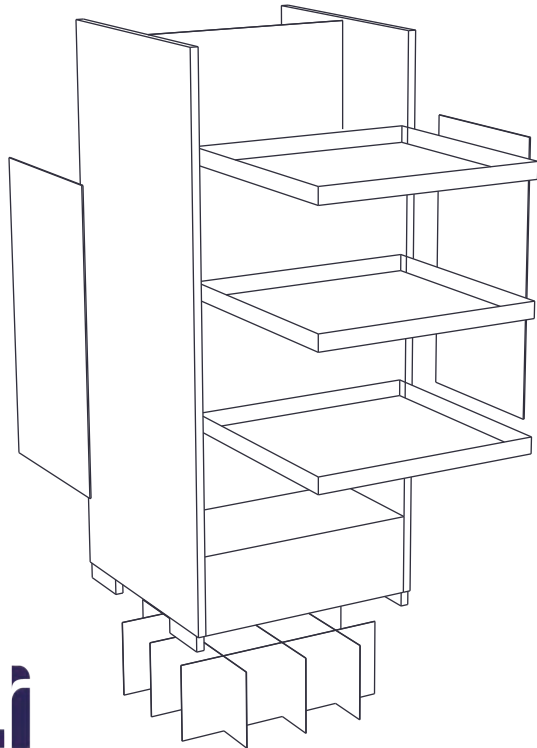

Delivery:
Folded in box;
on pallet

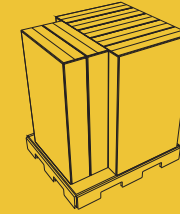

Augmented Reality



Load per level 25 Kg.



Space for product
55 x 55 cm



Tray height
26 cm

Bottom
19 cm



Width
60 cm



Height
140 cm

Depth
60 cm

Sidekick

SD_004

- Manufactured in corrugated cardboard
- Easy to hang system from shelf sides
- Designed for quick setup at retail
- Options for hanging and tray products

- Unfold it to assemble, secure trays and place at retail.



Video

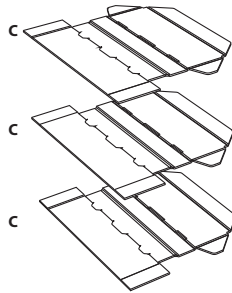

Delivery:
Folded in box;
on pallet

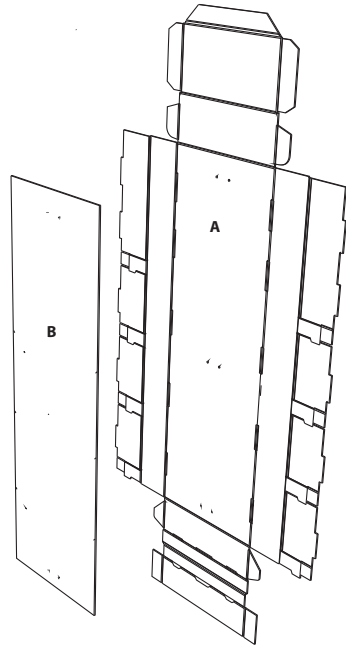
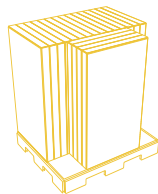

Perfect size to fit in a small car



Load per level 1.5 Kg.



Space for product
38 x 10 cm



Augmented
Reality

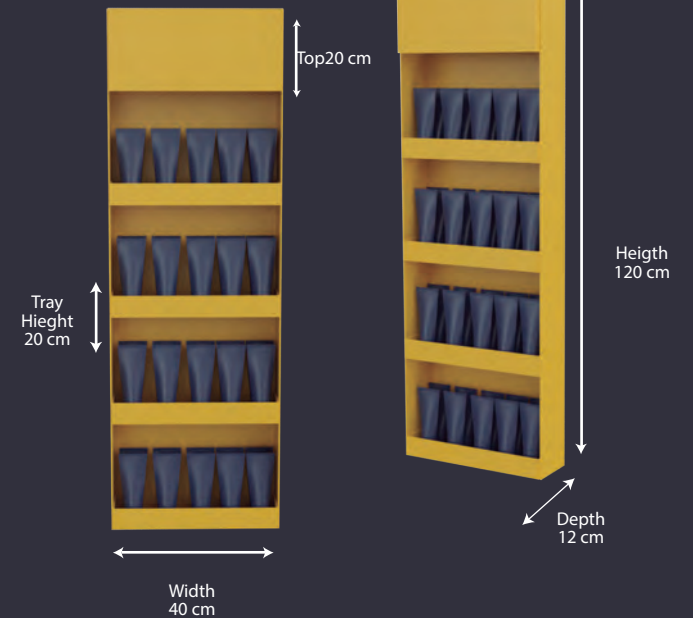

Small Sidekick

SD_013

- Manufactured in corrugated cardboard
- Designed for quick setup at retail
- Large branding area
- Unfold it to assemble and place at retail



Video

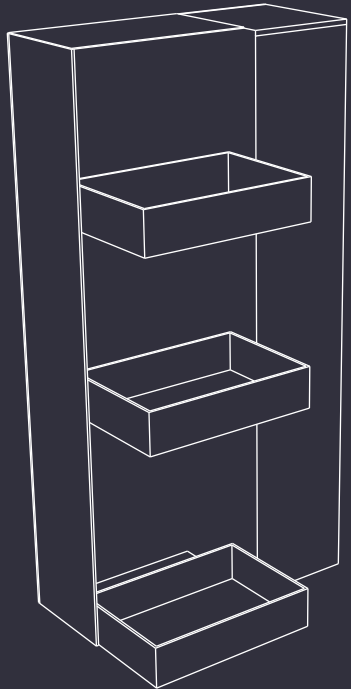

Load per level 1 Kg.



Space for product
14 x 19 cm



Augmented Reality



Width
35 cm



Height
68 cm

Depth
13 cm



Perfect size to fit in a small car

Long Sidekick

SD_016

- Manufactured in corrugated cardboard
- Designed for quick setup at retail
- Ideal for multi-brand exhibition and temporalities

- Unfold it to assemble and place at retail.



Video

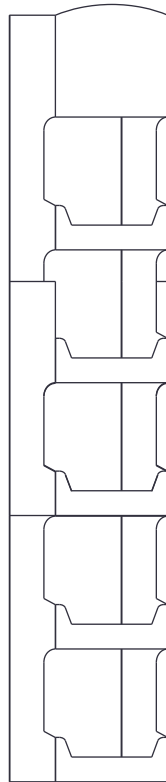

 Load per level .5 Kg.
 Space for product
8 x 5 cm



Augmented Reality

Perfect size to fit in a small car

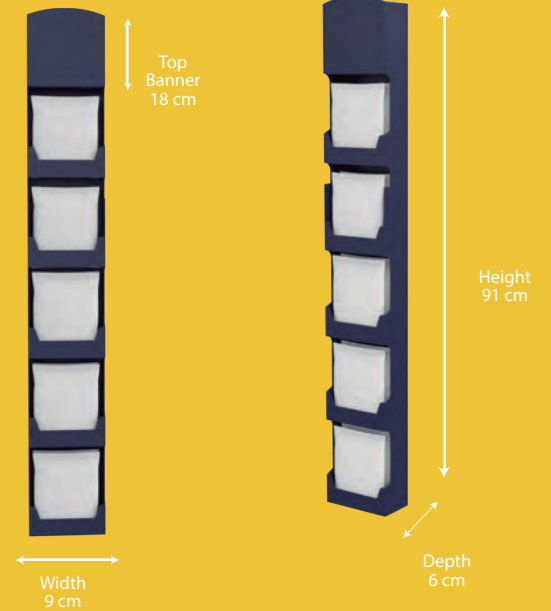

Endcap One-Piece PDQ Tray

SD_012

- Manufactured in corrugated cardboard
- Designed for quick setup at retail
- Large space for branding
- Unfold it to assemble and place at retail.



Video



Perfect size to fit in a small car

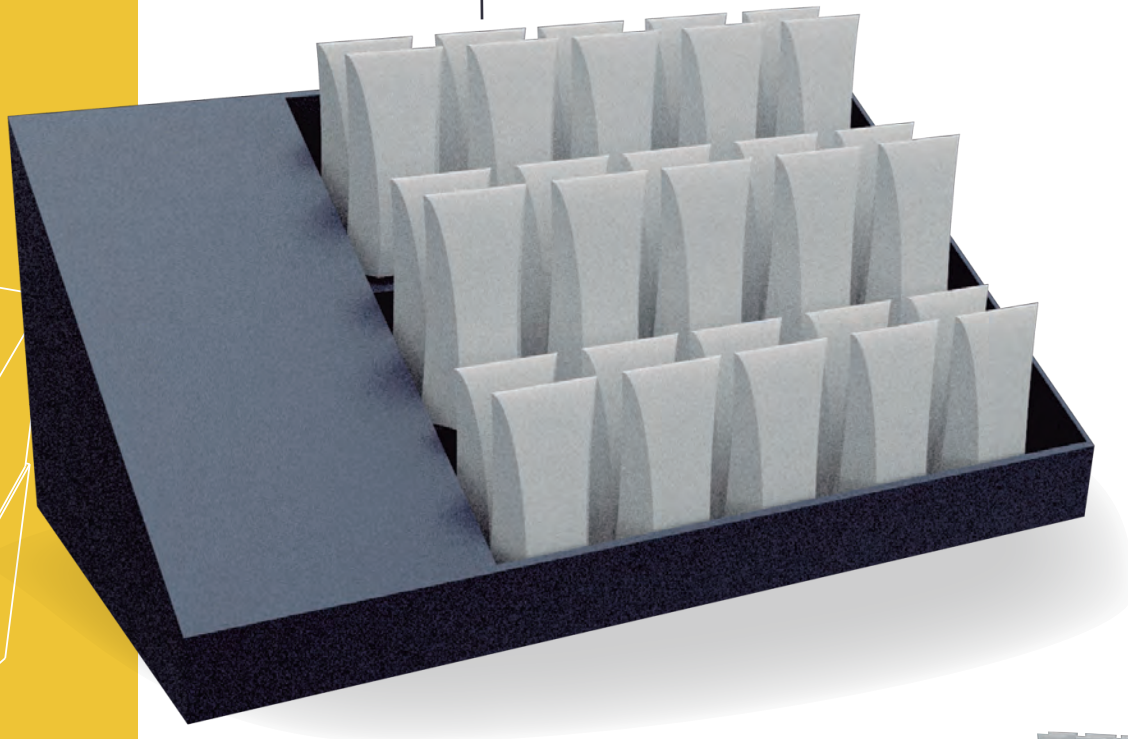

Load per level 1 Kg.



Space for product
52x 34 cm



Augmented
Reality

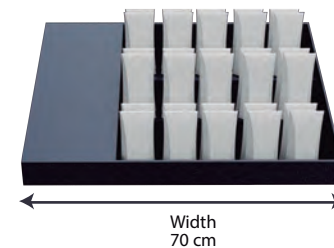

Counter One-Piece PDQ Tray

SD_020

- Manufactured in corrugated cardboard
- Designed for quick and easy setup at retail
- Ideal for counter product visibility, large space for branding

- Unfold it to assemble and place at retail.



Video

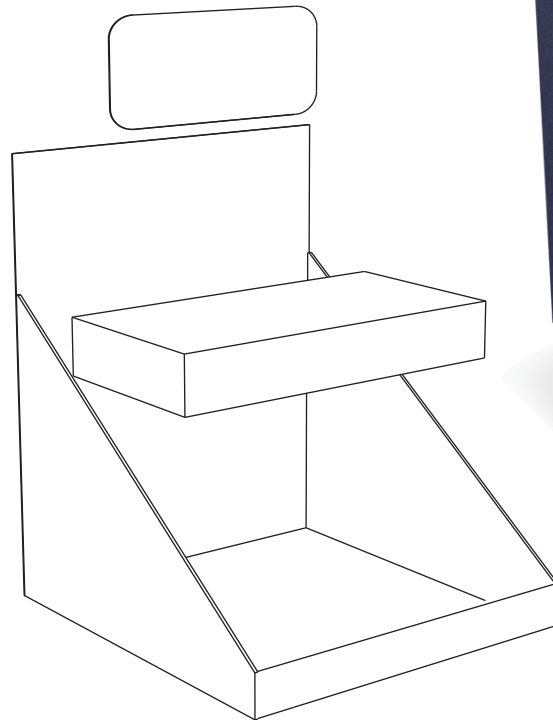

Load per level 4 Kg.



Space for product
37 x 27 cm



Augmented
Reality



Perfect size to fit in a small car



Width
38 cm

Top
Banner
14 cm



Depth
28 cm

Height
30 cm



Tiered Pallet Display

SD_006

- Manufactured in corrugated cardboard
- Reinforced design supports heavier products
- Unfold it to assemble and place at retail.



Delivery:
Folded in box; on
pallet

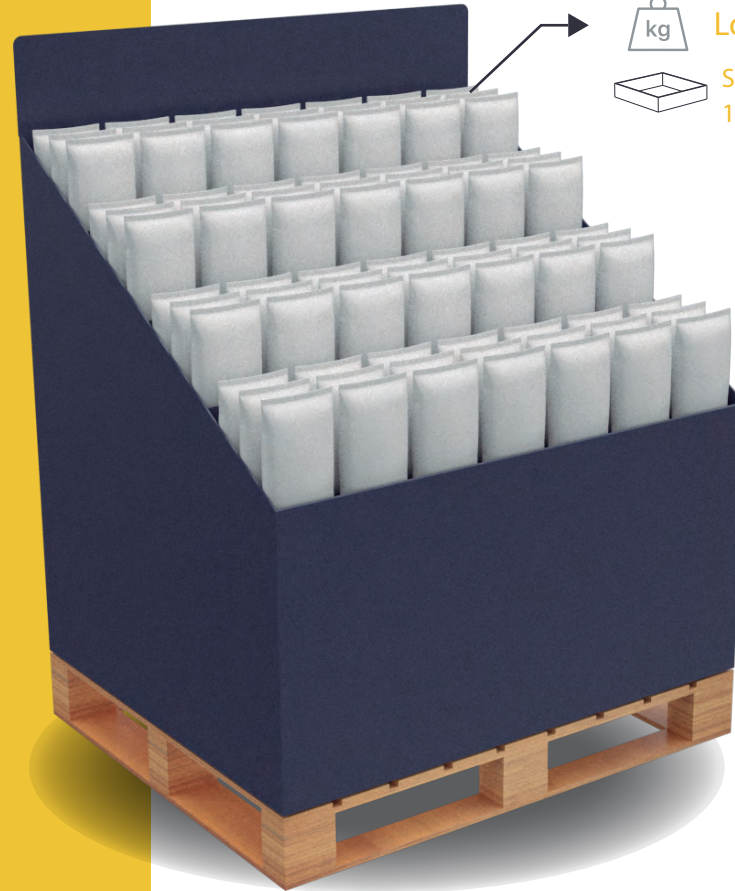
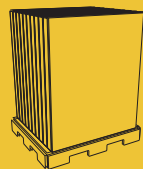

Load per pallet 100 Kg.



Space for product per
119 x 23 cm



Augmented
Reality

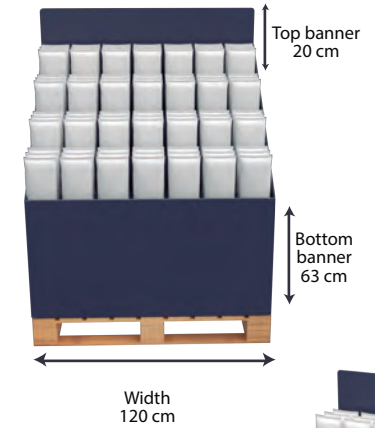

Width
120 cm

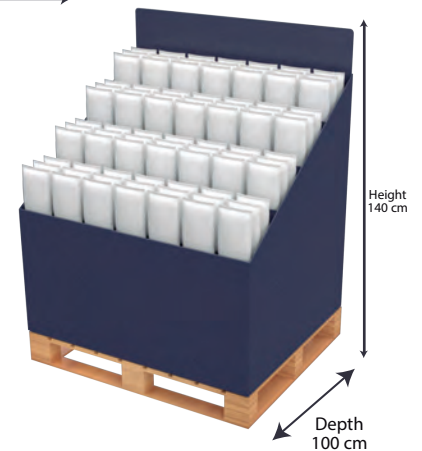

Height
140 cm

Depth
100 cm

Double sided View

SD_008

- Manufactured in corrugated cardboard

Delivery:
Folded in box; on pallet

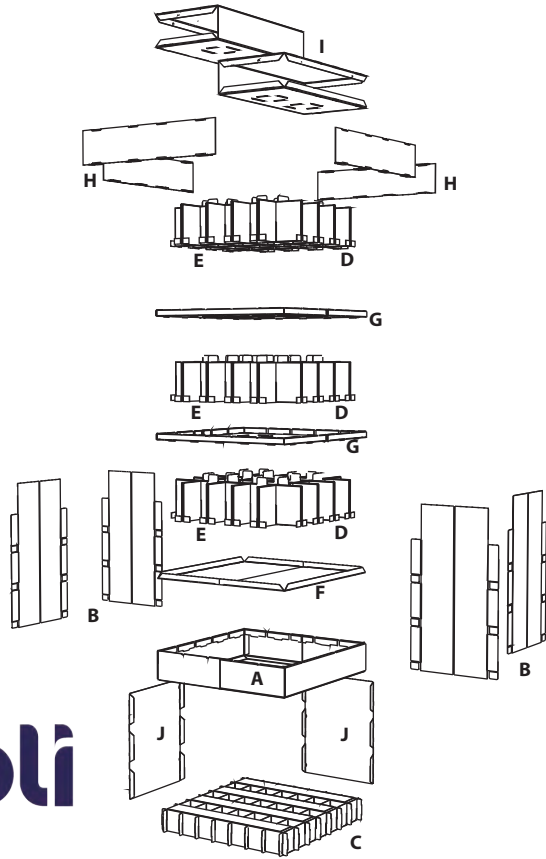
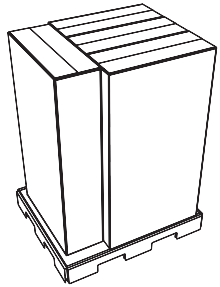

kg Load per 110 Kg.

Espacio para producto(Cara larga)
94 x 22 cm

Espacio para producto(Cara corta)
74 x 22 cm



Augmented Reality

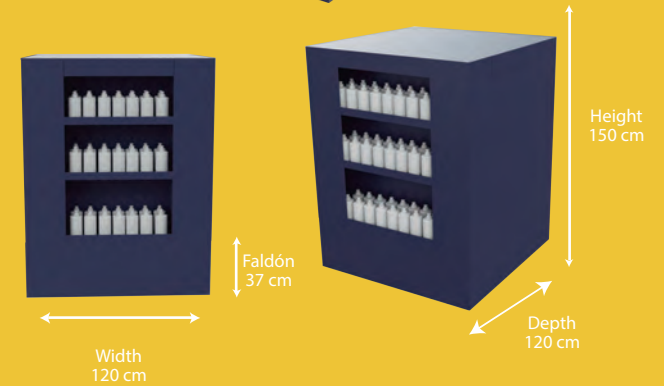

Pallet Display Dump Bin



SD_011

- Manufactured in corrugated cardboard
- Designed for quick and easy setup at retail
- Reinforced design supports heavy loads
- Large space for branding
- Unfold it to assemble and place at retail.

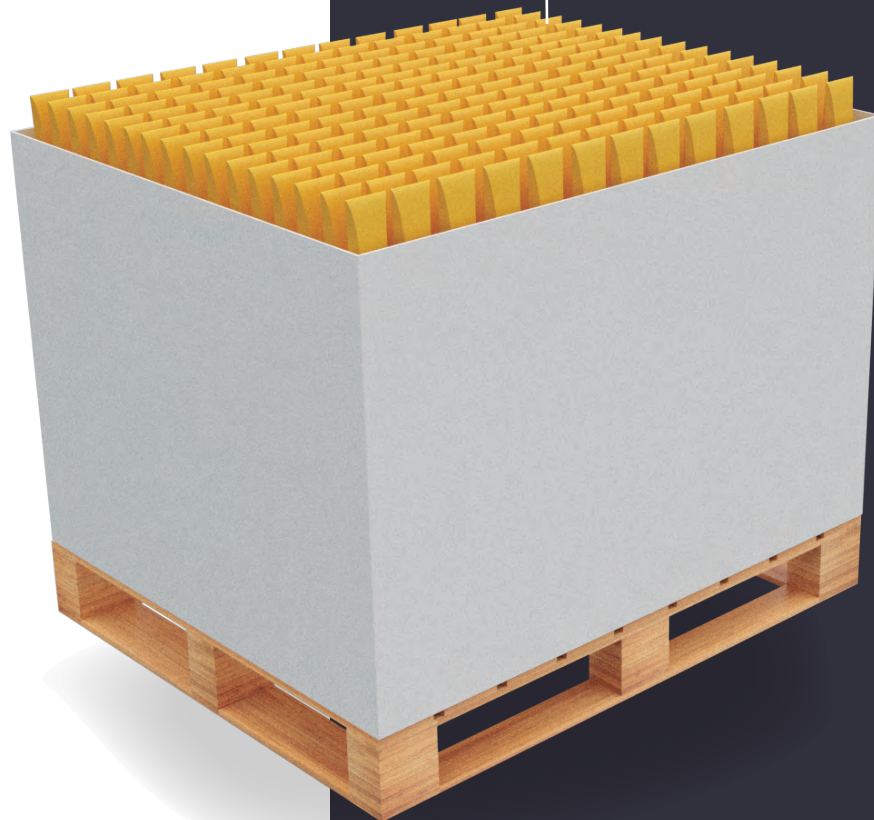
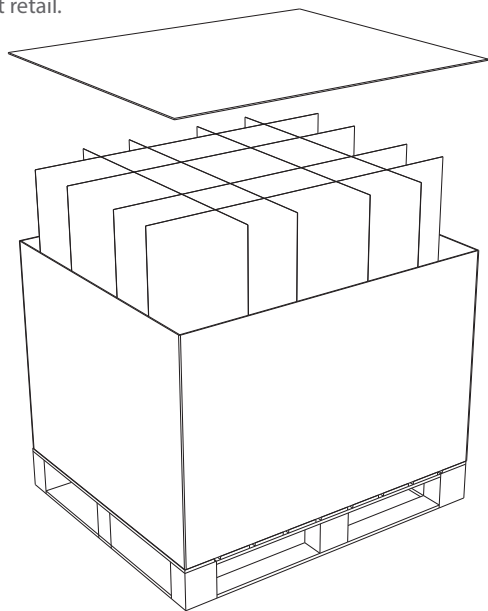

Video



 Load per level 50 Kg.
 Space for product
119 x 99 cm

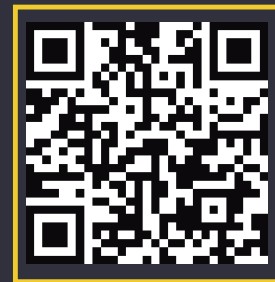

Augmented
Reality

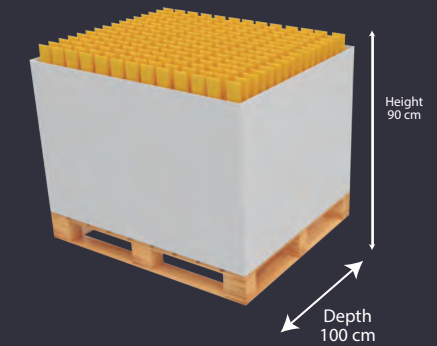
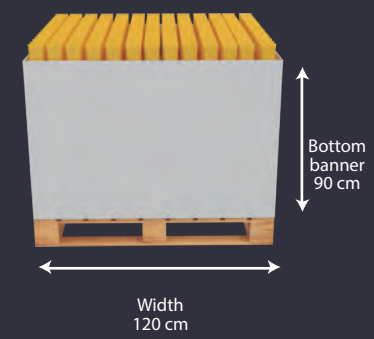

Pallet Display

SD_017

- Manufactured in corrugated cardboard
- Designed for quick and easy setup at retail
- Unfold it to assemble and place at retail.

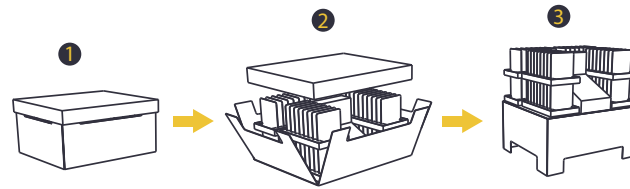
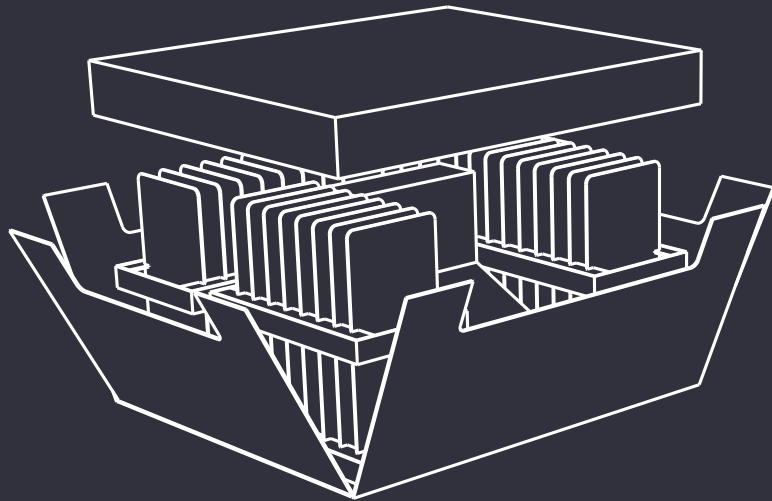

Tamaño de charola
59 x 35 cm

Tamaño de tarjeta (64 pzas)
28 x 33 cm



Augmented
Reality

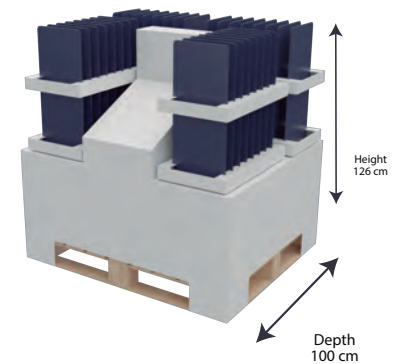
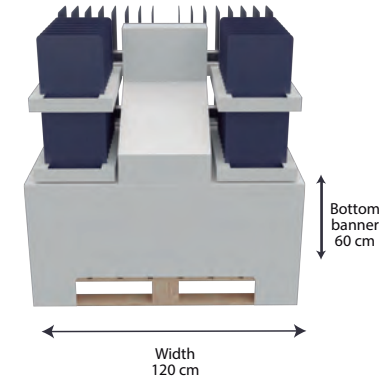
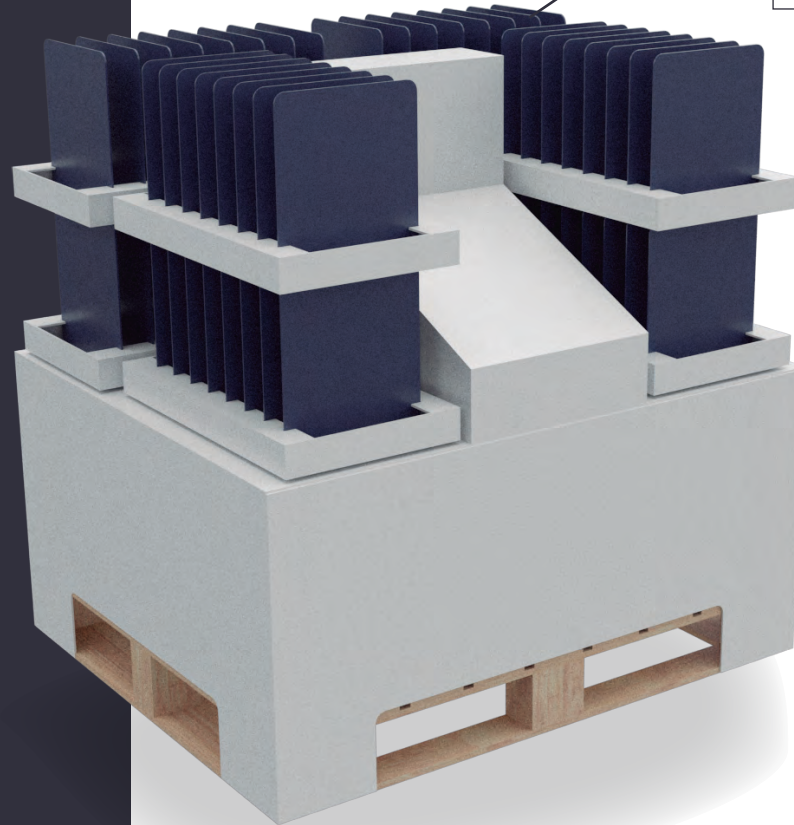

Perfect size to fit in a small car

False Pallet

SD_018

- Manufactured in corrugated cardboard
- Designed for quick and easy setup at retail
- Large space for branding

- Unfold it to assemble and place at retail.

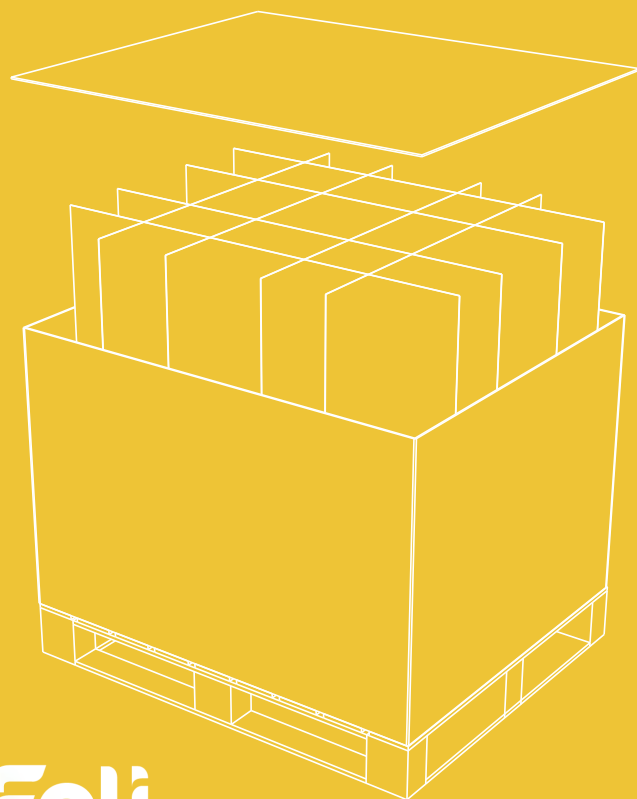

Tamaño de caja perfecto para cualquier cajuela de automovil



Load per level 50 Kg.



Space for product
119 x 99 cm

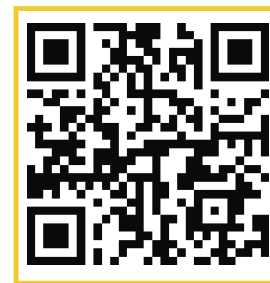

Augmented Reality

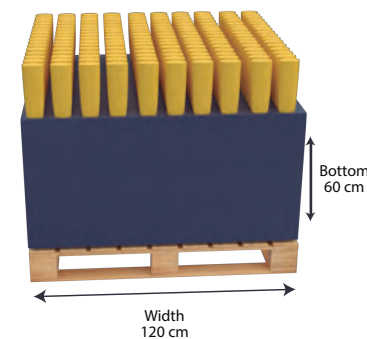
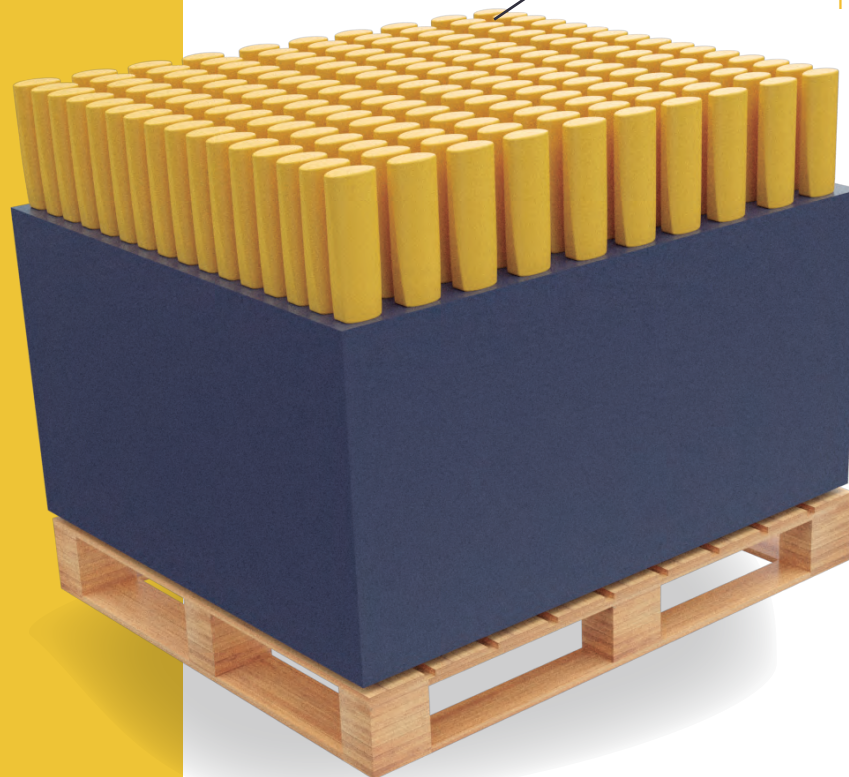

Width
120 cm

Bottom
60 cm

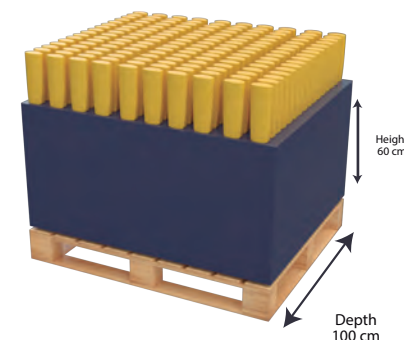

Height
60 cm

Depth
100 cm



Maxi - Tray

SD_019

- Manufactured in corrugated cardboard
- Designed for quick and easy setup at retail
- Easy to stack
- Unfold it to assemble and place at retail.

Assemble in
1
Minutes



Video

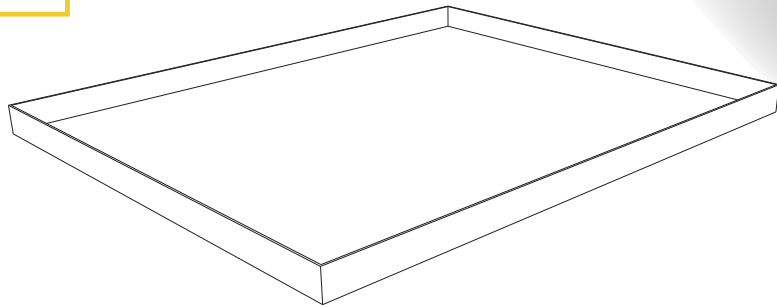

Space for product
119 x 99 cm



Augmented
Reality



Perfect size to fit in a small car

Height
6 cm

Width
120 cm

Depth
100 cm



Banner Display With base

SD_014

- Manufactured in SBS board and coroplast
- Semi-automatic assembly
- Ideal for branding

- Unfold it to assemble and place on top of base



Video

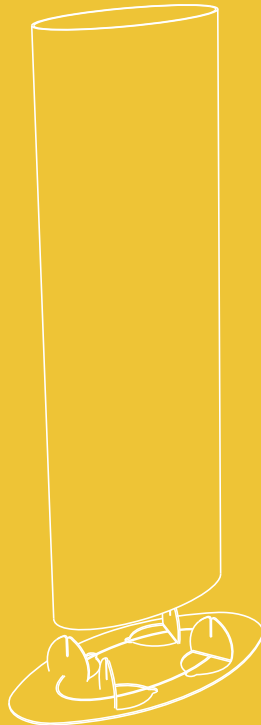

Perfect size to fit in a small car



Augmented
Reality

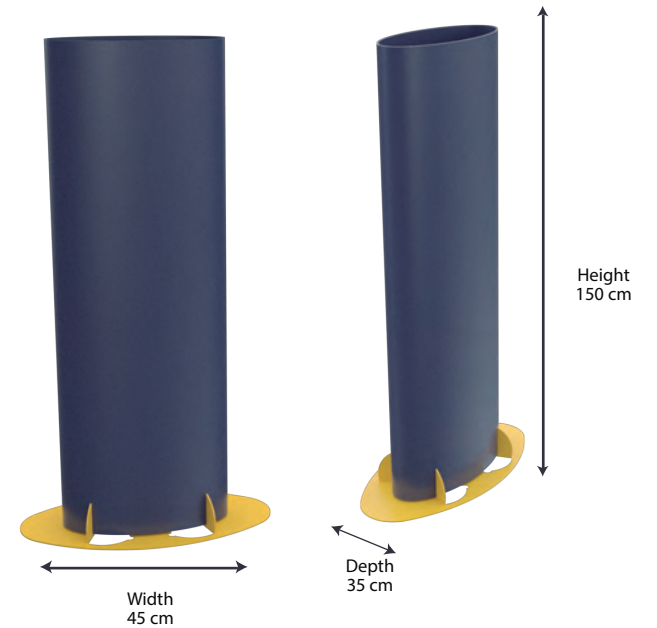

Standee

SD_015

- Manufactured in corrugated cardboard
- Ideal for branding
- Customizable shape, 40cm pop-out can be added

- Unfold it to assemble



Video



Assemble in
30
Seconds

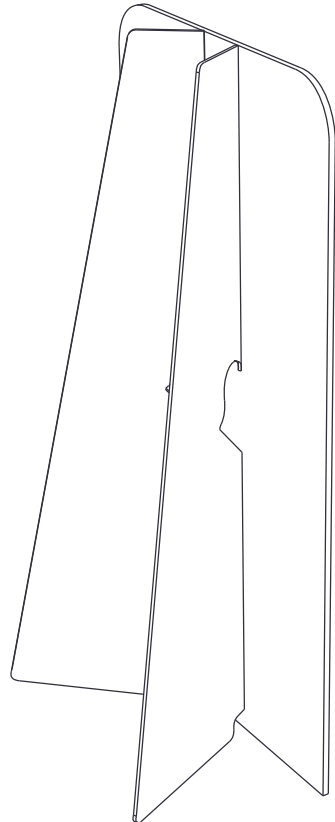

Customizable shape



Perfect size to fit in a small car



Augmented Reality



Width
45 cm



Height
140 cm

Depth
40 cm